



**MEFE**  
MITCHELL ENGINEERING  
FOOD EQUIPMENT PTY LTD

# Instruction Manual



## Knife Steriliser

CAT 68 10N2

Revision 1

# Contents

<b>1. Product Description</b> .....	3-4
<b>1.1</b> General Functions and Fields of Application, Intended Use .....	3
<b>1.2</b> Technical Specifications .....	3
<b>1.3</b> Ambient Conditions .....	3
<b>1.4</b> Security Information .....	3-4
<b>2. Preparatory Steps for Operation</b> .....	4
<b>2.1</b> Unpacking.....	4
<b>2.2</b> Installation.....	4
<b>3. Operation Instructions</b> .....	4
<b>3.1</b> Preconditions for Safe Operation .....	4
<b>3.2</b> Regular Function .....	4-5
<b>3.3</b> Initial Startup.....	5
<b>3.4</b> Operator Safety.....	5
<b>4. Closing Down and Restarting</b> .....	6
<b>4.1</b> Closing Down.....	6
<b>4.2</b> Restarting .....	6
<b>5. Cleaning and Maintenance</b> .....	6
<b>5.1</b> Safety Precautions.....	6
<b>5.2</b> Cleaning and Maintenance by Qualified Personnel.....	6-7
<b>5.3</b> Necessary Maintenance Work .....	7
<b>5.4</b> Corrosion .....	8
<b>5.5</b> Maintenance and Cleaning .....	8-9
<b>6. List of Spare Parts</b> .....	10
<b>6.2</b> Final Closing Down .....	10
<b>7. Annex</b> .....	11-12

## 1. Product Description

### 1.1 General Functions and Fields of Application, Intended Use

Before starting the Sterilizer, read this manual thoroughly in order to become familiar with all the requirements and characteristics when handling this unit.

The Sterilizer is designed to solely disinfect knife blades with an overall length of 22cm max.

It is purpose-designed for commercial use in all hygienic and sanitary areas in the food processing industry.

It is not suitable to heat liquids for food manufacture and/or to prepare food.

Any other improper use is not regarded as being in accordance with the intended purpose of application.

We do not take any liability for damages resulting thereof!

### 1.2 Technical Specifications

Mains Connection	240V / 50Hz
Cable Connection	Connection pipe 3 x 15mm <sup>2</sup> with protected plug
Basin Heating Unit	1000W
Fresh Water Connection	Tube Ø10mm, a ball valve or similar piece of equipment is to be provided on site.
Waste Water Connection	Pipe 25mm

### 1.3 Ambient Conditions

The sterilizer is designed for in-house, stationary use.

Moreover, the installation floor and/or wall should have a slip-resistant and easy-to-clean surface.

The lighting on site must comply with the guidelines for workplaces.

### 1.4 Security Information

Use the knife sterilization unit solely in accordance with the security guidelines. Pay attention to possible causes of accidents and risks for machine and operating staff.

Installation and repair work must be carried out by qualified personnel only!

In case of closing down or dismantling this piece of equipment, all parts which can cause risks must be removed.

This manual only informs about possible dangers when using the Knife Sterilizer. It is the buyer and his personnel who are responsible for avoiding them!

The buyer/user of this machine is obliged to make his staff familiar with all operating instructions as well as with the corresponding accident prevention regulations and all other regulations for operational safety.

The Knife Sterilizer is suitable solely for the purpose as described herein.

Take care that nobody can come into contact with the electrical power. The Knife Sterilization unit is to be operated with the voltage indicated in this manual only. Prior to any repair or maintenance work the unit must be disconnected from the electrical mains!

Each failure has to be immediately reported to the superior. If part or all of the safety system is missing or does not work the unit must not be started. Moreover, observe all maintenance intervals.

Never start the knife sterilization unit without water!

## 1.4 Security Information Continued

Never start the knife sterilization unit without water!

MEFE does not take any liability for damages resulting from improper handling or non-compliance with the instructions of this manual.

In case of questions regarding function, handling and spare parts delivery please contact your supplier.

## 2. Preparatory Steps for Operation

### 2.1 Unpacking

Unpack the unit and dispose of the waste material appropriately.

### 2.2 Installation

When installing the Knife Sterilizer strictly observe the pertinent national regulations.

The unit must be installed by qualified persons only.

Prior to installing the unit all necessary supply and waste connections (electrical power, water, waste water) must be provided on site.

Fasten the Knife Sterilizer with four screws at the wall of the selected place of operation in the vicinity of an electrical socket or mains connection unit. The feeder cable is approx. 1.5m long.

The fresh water supply pipe on site must be equipped with a shut-off valve (ball valve).

The Knife Sterilizer itself is connected via a terminal piece (10mm).

Connect the water outlet adequately to your drain system.

Attention: In case of very fatty waste water, install an integrated fat separator on site.

The outlet pipe comes with a diameter of 25 mm.

## 3. Operation Instructions

### 3.1 Preconditions for Safe Operation

Disregarding or omitting the instructions of this operation manual can lead to serious personal injuries.

The machine must be used solely by persons which have been made familiar by their superiors with all its functions and modes of operation prior to handling it. Any functional irregularities must be immediately reported to the superior!

All maintenance and repair work must be carried out by qualified personnel only, which are acquainted with the operational safety regulations.

The direct connection of the unit to the electrical mains on site as well as all maintenance work at the electrical appliances must be carried out by correspondingly trained personnel with electro technical qualifications only.

### 3.2 Regular Function

The Knife Sterilizer unit is made of a double-walled insulated basin of stainless steel grade 304.

The water is heated electrically via a heater element as soon as the unit is connected with the electrical mains.

### 3.2 Regular Function Continued

The water temperature is controlled by a thermostat. This thermostat is set to 85° C. Moreover, the thermostat comes equipped with a temperature limit controller which functions as a dry-run protection appliance. If the heater element is heating although there is no water in the basin, the heater element is shut off automatically when reaching a temperature of approx. 135° C.

In this case the safety fuse in the temperature limit controller is activated and pops out. In order to restart the unit the fuse button has to be pushed down again (see picture Below)

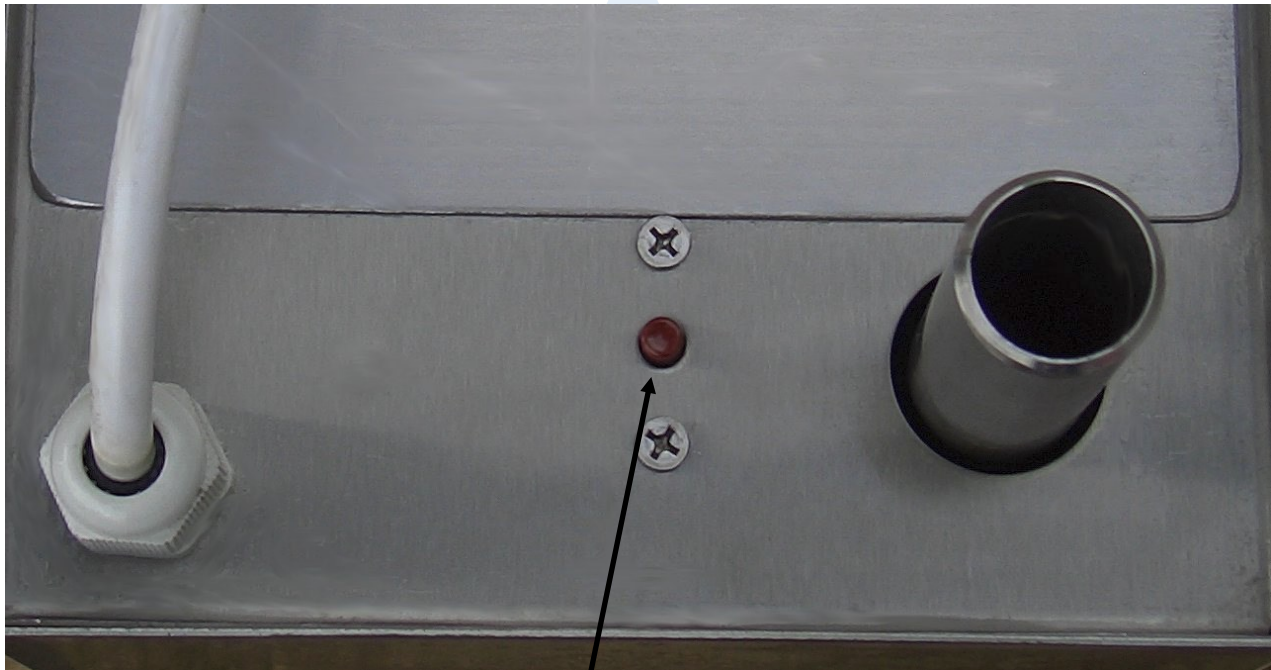

*Fuse button of the temperature limit controller*

### 3.3 Initial Start Up

To initially start the Knife Sterilizer proceed as follows:

- Open the water in-feed valve and fill the basin up to the top edge of the stand pipe.
- Plug-in the electrical cable or switch on the mains.
- The water in the basin is heated to a temperature of 85°C. The time needed to reach this temperature depends on the temperature of the fed-in water (at a temp. of 20°C this will take approx. 30 min.).

In compliance with the regulations of hygiene and sanitation, the fresh water supply must remain open to a degree allowing fat and meat particles as well as other dirt particles to be constantly rinsed off through the stand pipe during operation.

### 3.4 Operator Safety

The unit must be operated by instructed personnel only.

It is solely purpose-designed to sterilize knife blades and is not allowed to be used for any other purposes.

This unit must never be used by children unless attended by an adult.

## 4. Closing Down and Restarting

### 4.1 Closing Down

Close down the unit as follows:

- Disconnect it from the electrical mains via the main switch or plug.
- Shut off the water supply and let the water in the basin flow off. For this purpose remove the stand pipe from the basin.
- Then remove the knife holder and the cover of the heater element.
- Then clean the unit as described in chapter 5.

### 4.2 Restarting

Restart the unit as follows:

- At first reinsert the cover of the heater element and the knife holder as well as the stand pipe.
- Then open the water supply.
- Finally reconnect the unit to the electrical mains by the main switch or plug.

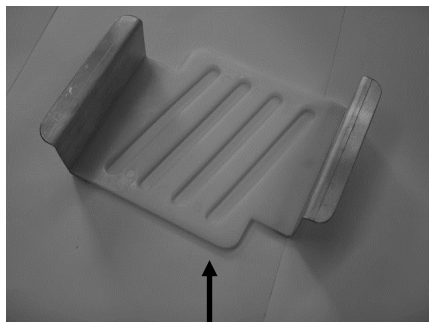

Knife Holder

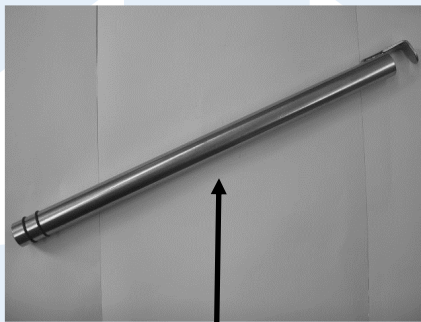

Stand Pipe

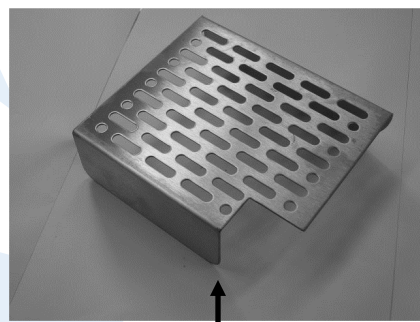

Cover of the Heater Element

## 5. Cleaning and Maintenance

### 5.1 Safety Precautions

In order to grant a safe cleaning the unit must be disconnected from the water and electrical supply net (main switch/plug).

### 5.2 Cleaning and Maintenance by Qualified Personnel

The unit is to be cleaned by qualified personnel only!

For reasons of hygiene and sanitation, daily cleaning is absolutely necessary.

To clean the unit, proceed as follows:

- Shut off the water supply and disconnect the unit from the electrical mains (main switch/plug).
- Remove the stand pipe in order let the water in the basin flow out.
- Then remove the cover of the heater element as well as the knife holder from the basin.
- Now the coarse dirt can be removed by hand.
- Then check the waste water outlet for free passage and rinse the basin.

## 5.2 Cleaning and Maintenance by Qualified Personnel Continued

- We recommend to clean the unit's surface with a suitable stainless steel cleaning detergent.
- If necessary repeat the cleaning steps until all soiling's are removed.
- After the cleaning process, reinsert the stand pipe, the cover for the heater element as well as the knife holder.
- Finally reconnect the unit to all supply pipes.

**Note! Never clean the unit with a high-pressure cleaner and/or chlorine containing detergents! Use food-grade detergents only!**

## 5.3 Necessary Maintenance Work

All maintenance work must be carried out by qualified staff only! During all maintenance work the unit must be disconnected from the electrical mains!

Only use original spare parts when exchanging damaged components.

When making technical changes at the machine, be it adding or removing components or altering components without our explicit approval, the CE conformity declaration as well as our liability for warranty claims will be expired!

After cleaning regularly check all parts for wear or damage, function and durability.

Repair and inspection work must be carried out by trained expert personnel only.

Decalcify the Knife Sterilizer with usual decalcifiers approx. every 150 operating hours.

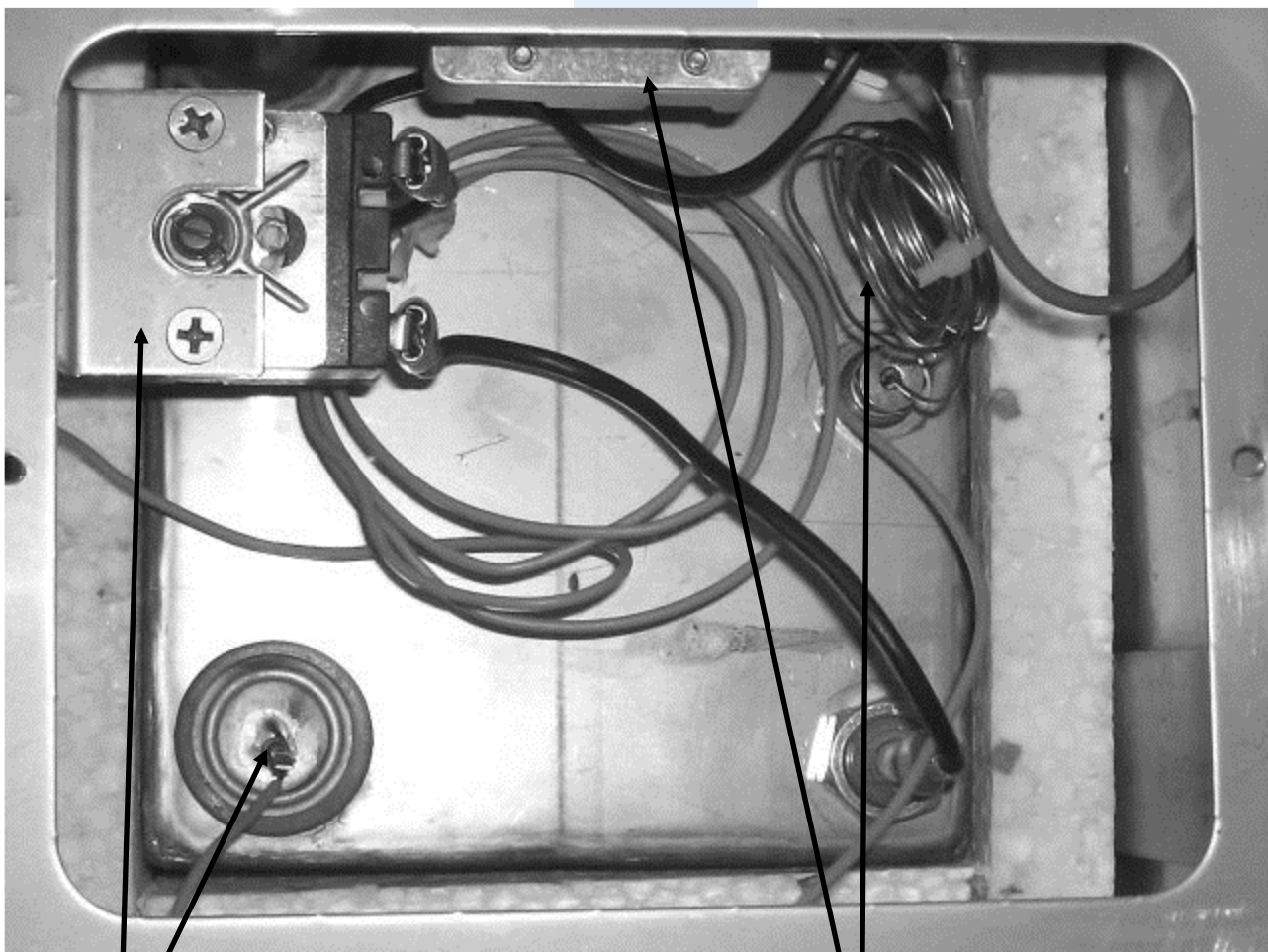

Thermostat with Sensor

Temperature limit control

## 5.4 Corrosion

Although, the passive layer is formed on stainless steel surfaces, **there are cases when it corrodes due to the following conditions:**

- Influence of hydrochloric acid and chlorine,
- No ongoing maintenance which leads to the formation of strong acid solutions on steel walls (water evaporates and an acid solution remains),
- An environment more aggressive than the steel provided for it;
- Contamination during installation and manufacture (lime, cement, foreign metallic inclusions as a result of using angle grinders nearby or unsuitable assembly tools),
- Contact with normal carbon steel (scratching with black steel during transportation or storage),
- Insufficient room ventilation or even their absence in aggressive environments (there must always be an air flow in ventilation ducts).

Symptoms of stainless steel corrosion are different. One can notice that corrosion appears usually on various types of internal (non-metallic inclusions, separations, deformations) and external (edges, scratches, dents, residues of scale, sediments, etc.) surfaces, while smooth and homogenous surfaces are much more resistant to corrosion. Therefore, it is necessary to ensure proper pickling and passivation of a surface.

The mechanism of destruction and the type of corrosion depend on a specific environment and steel affected by it. The following types of corrosion may occur depending on the environment and stainless steel:

- Surface (uniform), Pitting, Intergranular, Stress, Crevice.

Pitting corrosion is the most frequently occurring corrosion caused by inappropriate stainless steel maintenance, more specifically due to the use of chlorinated cleaning agents.

Pitting corrosion is a form of a localised environmental attack leading to local losses (pits) in material. It is caused by the influence of galvanic cells formed between a passivated steel surface and clearly localised non-passivation areas laying on it. Oxygen or oxidising substances in a cathodic cell areas (passivated) are required for pitting corrosion to occur. If they are absent, cathodic areas polarize and the cell stops functioning.

Solutions which cause pitting corrosion of stainless steels most frequently are chlorine solutions. For this type of corrosion, condition of a steel surface is very important. The smoother and cleaner the surface, the smaller the intensity of said corrosion.

A quality assessment of the effects of this type corrosion is difficult, since damage can be very serious at a minor weight loss. It is assumed that an average number of pits per area unit and their greatest depth can serve as some indicators.

## 5.5 Maintenance and Cleaning

When using stainless steel furniture and equipment, a layer of chromium oxide present on the steel surface must be taken care of. Compounds used in food industry which disturb the passive layer (chromium oxide) include compounds containing chlorides – salt, disinfectants and acids (water from sauerkraut, cucumbers, acid juices, vinegar, etc.). Water is the most effective neutraliser of chlorides and weak acids.

Stainless steel is not an exception to this rule and each user must be aware that regular cleaning and maintenance of stainless products is required.



## 5.5 Maintenance and Cleaning Continued

Cleaning should remove dirt and sediments, which left for too long on a stainless steel surface may initiate corrosion and tarnishing of the surface. In a highly contaminated or aggressive environment (seaside towns, rooms of increased humidity and temperature, rooms requiring frequent use of disinfectants, in particular containing chloride compounds), cleaning should be done more frequently. The frequency of cleaning should be empirically determined.

In order to prevent a surface of stainless steel equipment from being destroyed due to inappropriate maintenance, the following guidelines should be complied with:

The following should not be used: agents containing chlorides and bleach or – under any circumstances - silver cleaners.

- Steel wool, sand paper, rough cleaners, scouring, grinding and polishing powders, etc. are not to be used as they scratch the surface.

Steel pads for scouring or wire brushes can not be used – they can leave sediments of carbon steel on the surface which will eventually lead to material rusting.

First discolouration and dusts appearing during material use can be removed with a regular piece of cloth, chamois leather or a nylon sponge in case of higher contaminations.

If iron particles generated during installation, etc. appear on stainless steel components, they should be immediately removed. Such particles corrode, thus they can break the passive layer protecting stainless steel, leading to corrosion as a result. Such sediments should be removed mechanically or with stainless steel cleaning agents.

- If there are pits on a component, they should be pickled with acid or removed mechanically.

- Local discolouration, grease marks – if small, they can be removed with soap water.

**- Products for cleaning stainless steel and alcohol-based preparations can be used for cleaning – they do not pose a threat to the corrosion properties of stainless steel.**

- After cleaning, it is always recommended to polish the surface with a dry piece of cloth.

The table below presents the most frequent types of contaminations and methods of handling:

Contaminations:	Cleaners:
Finger Marks	Water with soap and detergent Glass cleaning agents without chlorides
Lime Sediment	Vinegar-water solution
Oil and Grease	Alcohol based agents (only with methyl alcohol, isopropyl alcohol) Solvents, e.g. acetone
Paints	Agents for removing paint coating, based on alkaline compounds / solvents
Cement and Mortar	Solvent containing a small amount of phosphoric acid, then water
Iron Particles - from tools / structural steel contact	At an early stage—mechanically If pits appear—with pickling and passivating pastes

The frequency of cleaning components made of stainless steel is individual – it all depends on the degree of wear and contamination. It should be done in frequent intervals so as to reduce the risk of stainless steel component rusting. The frequency of cleaning of stainless steel devices is analogous to the frequency of cleaning household sinks, stainless steel.

## 6. List of Spare Parts

Item	Description	Number	Qty
	Heater Element	CAT 66 10N	1
	Heater Element	CAT 66 10A	1
	Thermostat with Sensor	CAT 64 10N	1
	Temperature limit Controller	CAT 64 10NC	1
	Cover of the Heater Element	6810N1	1
	Knife Holder	6810N2	1
	Stand Pipe	6810N3	1
	Control Valve	CAT 66 101	Optional
	Elbow Coupling 10mm	CAT 66 102	Optional



### 6.2 Final closing down

When finally closing down and disposing of the unit take care to regard the correct waste disposal of the various unit components.

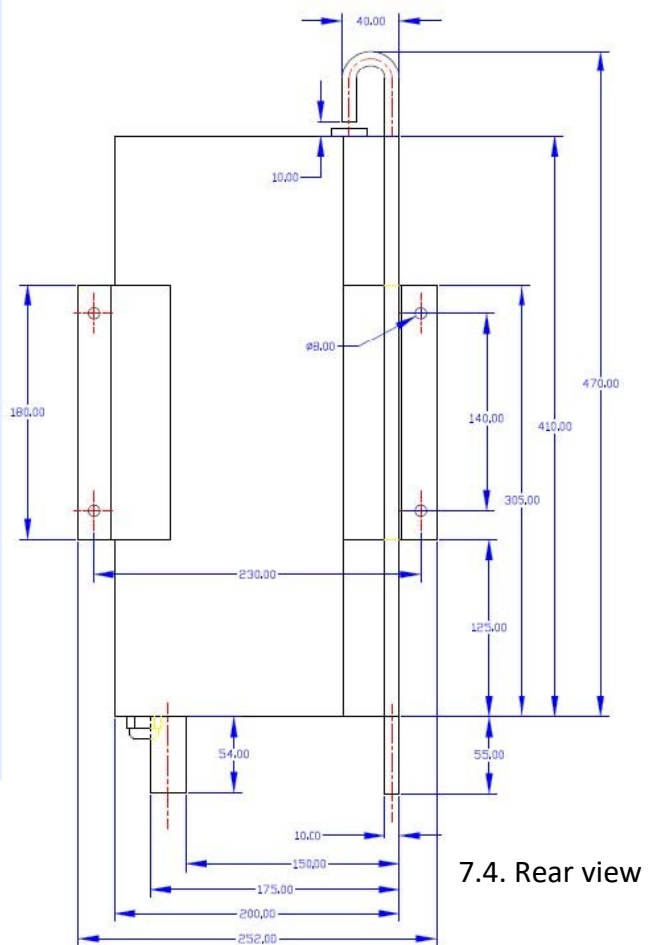
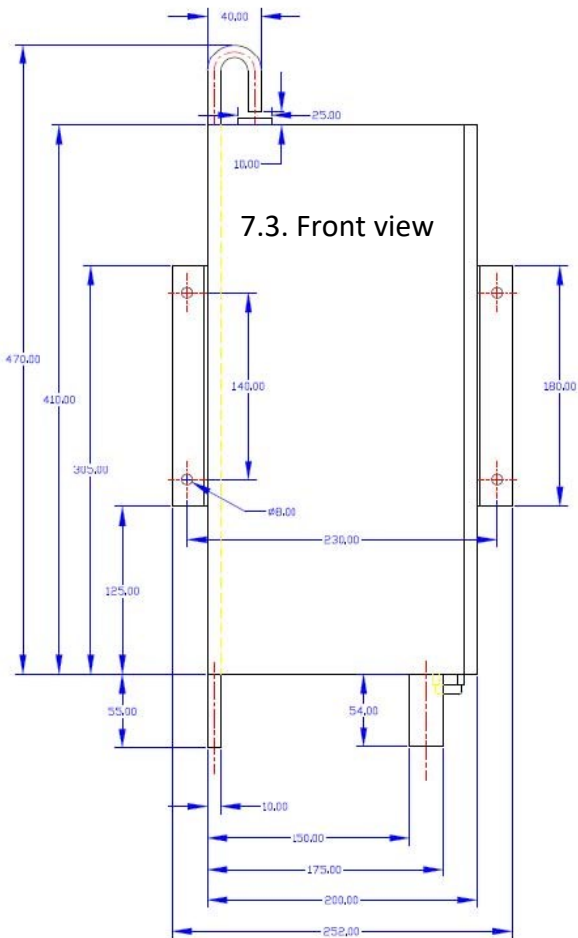
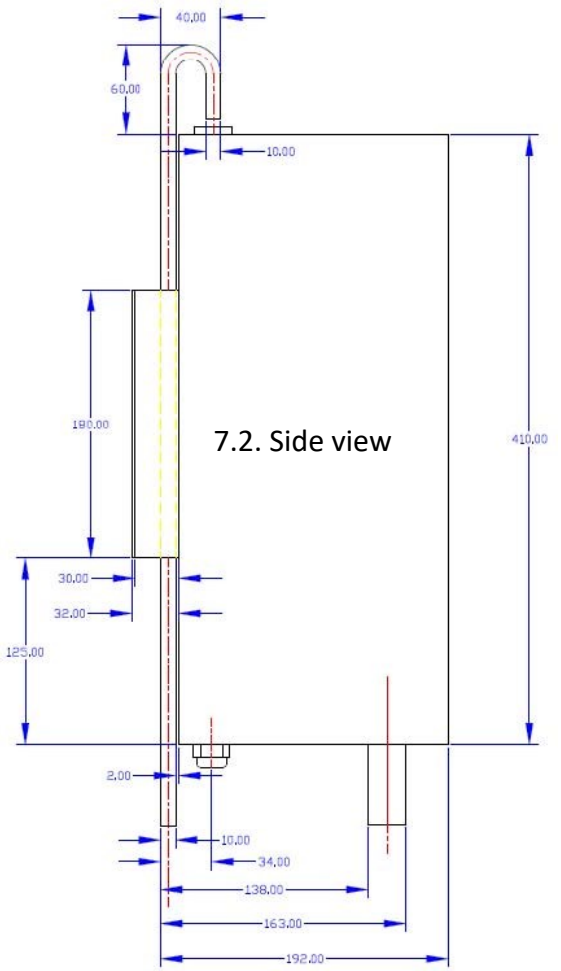
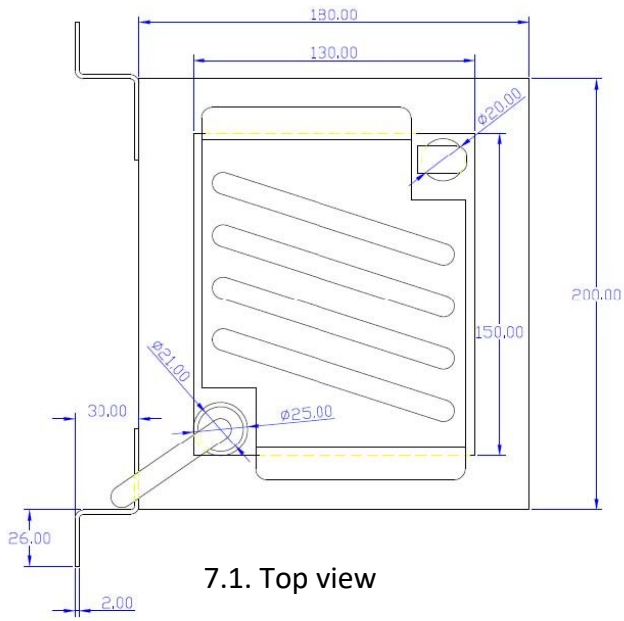
## 7. Annex

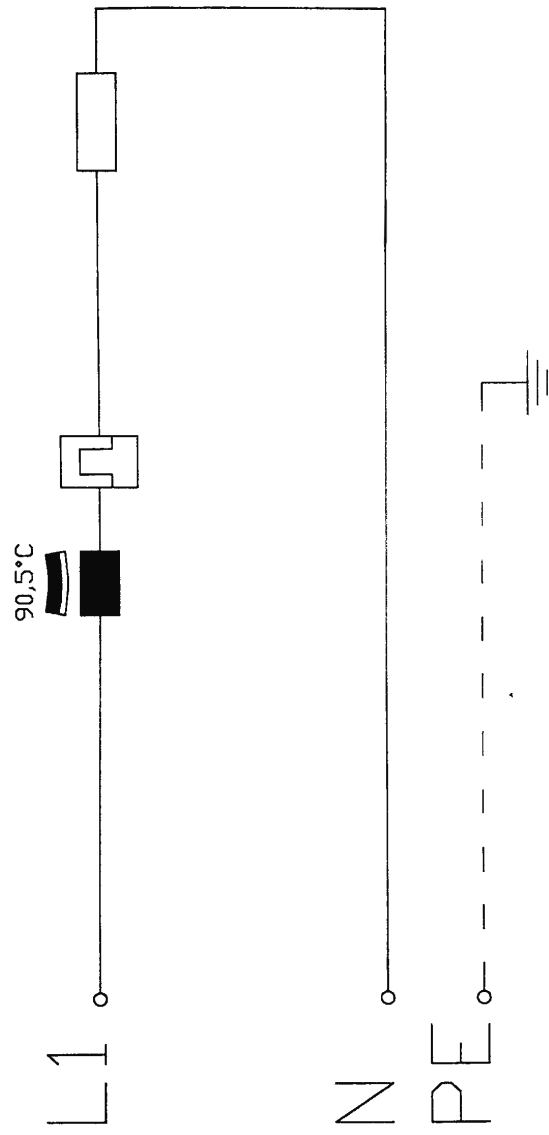



- 
 90,5°C  
 Thermostat Knopffühler
- 
 Temperaturschutzbegrenzer (506010-003)
- 
 Heizspirale 1000W